

# CITY

NO. 25102

6+ AGES  
CITY

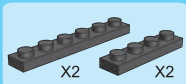

1

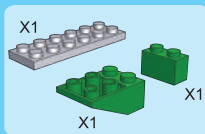
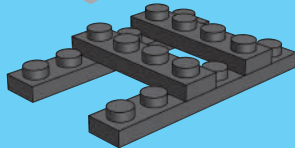

2

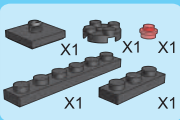
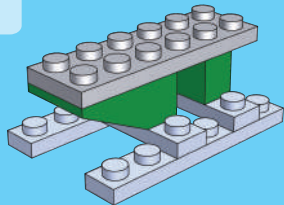

4

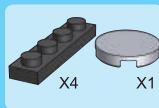
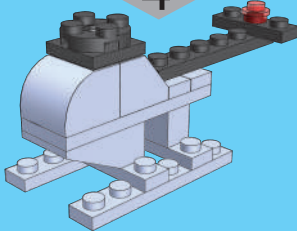

5

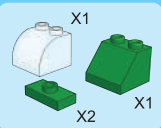
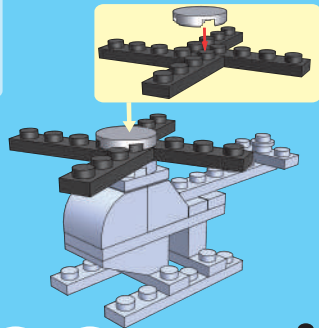

3

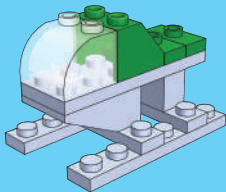

 **WARNING:**  
CHOKING HAZARD - small parts.  
Not for children under 3 years.

